

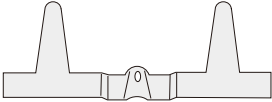

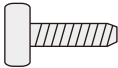

Parts List Better Box Double Box Mount

NO.	DESCRIPTION	PICTURES	QTY
1	Bottom Bracket		1
2	1 x M10 Bolt (M10*55MM)		1
3	2 X M10 Washers		2
4	1 X M10 Nut		1
5	Top Bracket		1
6	2 x M8 Screws (M8*45MM)		2
7	2 x M8 Washers		2
8	2 x M8 Nuts		2

Better Box Double Mailbox Assembly Instructions

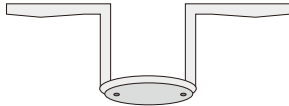
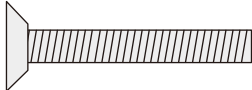

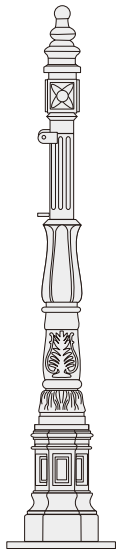
1. Unpack Post

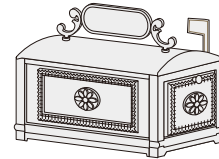
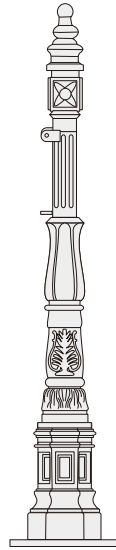

2. Unpack and assemble mailboxes per mailbox assembly instructions – Knob, flag, number plate



3. Final Better Box Double Mailbox assembly will require the single mount assembly on the post to face away from the curb.

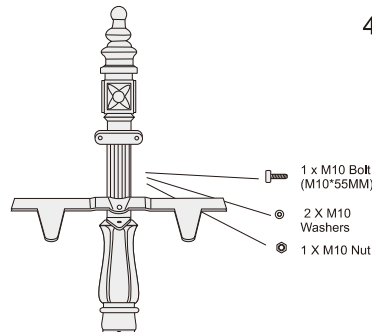

4. Attach the bottom bracket to the lower single box mount on the post as illustrated using the M10 bolt, M10 washer, and M10 nut. Note – recess on lower bracket marries to lower single post mount.

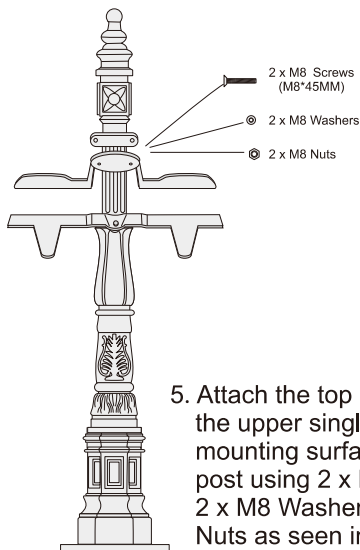

5. Attach the top bracket to the upper single box mounting surface on the post using 2 x M8 Screws, 2 x M8 Washers, and 2 M8 Nuts as seen in the illustration.

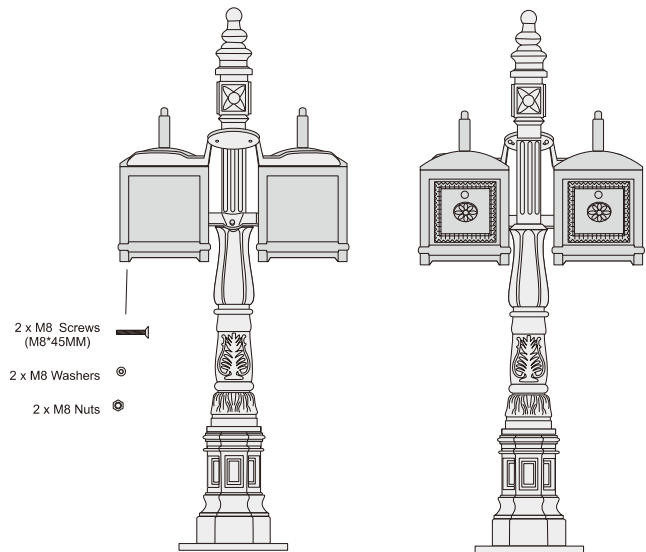

6. Attach the mailboxes to the double bracket using the M8 stud, M8 washer and M8 nut on the bottom and 2 x M8 screws, M8 washers, and M8 nuts on the top in accordance with single box mounting instructions.

Scrolls – Better Box Double Mailboxes were designed without scrolls. If you would like to add the scrolls to your new double box.....Attach the scrolls to the bottom of the mailboxes. Center the stud at the other end of the scroll on your Better Box post. Once you locate the position the scrolls rest on the post, drill small holes in the post and insert the stud at the end of the scrolls.